



Universal Display LTD

Pre SPEC
FOR
LCD MODULE

Customer : _____

Product Model: KD070D9-40NB-A12

Sample code: _____

Designed by	Checked by	Approved by

Contents

No.	Item	Page
1.	Numbering System	4/17
2	Scope	5/17
3	Normative Reference	5/17
4	Definitions	5/17
5	Block Diagram	7/17
6	Technology Specifications	7/17
7	Reliability Test	13/17
8	Handling Precautions	13/17
9	Precaution for use	15/17
10	Package Drawing	16/17
11	Outline Dimension	17/17

1. Numbering System

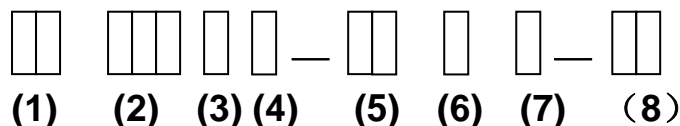

No	Definition	Specifications
(1)	TFT LCM Productor No.	KD
(2)	Display monitor opposite angle line size	Unit :mm or mmm (size <10 inch: takes two integers ; size >=10 inch: takes three integers)
(3)	Productor Types	D ---- Digital photo frame / DVD G ----GPS M ----MP P ----Mobil-Phone N ----Net Book
(4)	Productor Development Series No.	By two figures characters expression from 01 to 99
(5)	Interface PIN Number	By two figures characters expression from 01 to 99
(6)	With Touch Panel Or Not	T----With T/P ; N----Without T/P
(7)	LCD Type	A----AUO ; M----CMO ; C----CPT; B----BOE; L----LG; W----Wintek; H----HSD; T----Tianma; Y----Hydis; I----Hitach; S----Sharp... ..
(8)	Productor Development edition No.	By The English litters : A 1~ Z9

2. Scope

3. Normative Reference

GB/T4619-1996 《Liquid Crystal Display Test Method》

GB/T2424 《Basic environmental Testing Procedures for Electric and Electronic Products.》

GB/T2423 《Basic Testing Procedures for Electric and Electronic Products》

IEC61747-1 《SIXTH PART GB2828`2829-87 《National Standard of PRC》

4. Definitions

4.1 Definitions of Vop

The definitions of threshold voltage V_{th1} , V_{th2} the following typical waveforms are applied on liquid crystal by the method of equalized voltage for each duty and bias.

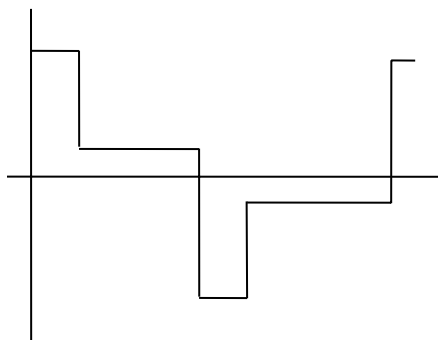

【 selected waveform 】

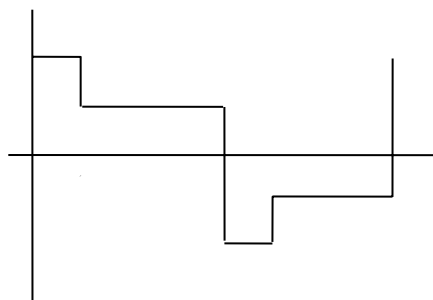

【 non-selected waveform 】

① V_{th1} : The voltage which the brightness of segment indicates 50% of saturated value on the conditions of selected waveform

($f_r=80\text{Hz}$, $\Phi=10^\circ$ $\theta=270^\circ$ at 25°C)

② V_{th2} : The voltage which the brightness of segment indicates 50% of saturated value on the conditions of non-selected waveform

($f_r=80\text{Hz}$, $\Phi=10^\circ$ $\theta=270^\circ$ at 25°C)

③ V_{op} : $(V_{th1}(50\%)+V_{th2}(50\%))/2$ ($f_r=80\text{Hz}$, $\Phi=10^\circ$ $\theta=270^\circ$ at 25°C)

4.2 Definition of Response Time T_r , T_d

① T_r : The time required which the brightness of segment becomes 10% from 100% when waveform is switched to selected one from non-selected one. ($f_r=80\text{Hz}$, $\Phi=10^\circ$ $\theta=270^\circ$ at 25°C)

② T_d : The time required which the brightness of segment becomes 90% from 10% when waveform is switched to selected one from selected one. ($f_r=80\text{Hz}$, $\Phi=10^\circ$ $\theta=270^\circ$ at 25°C)

4.3 Definition of Contrast Ratio C_r

$C_r=A/B$

- ① A: Segments brightness in case of non-selected waveform
- ② B: Segments brightness in case of selected waveform

4.4 Definition of Angle and Viewing Range

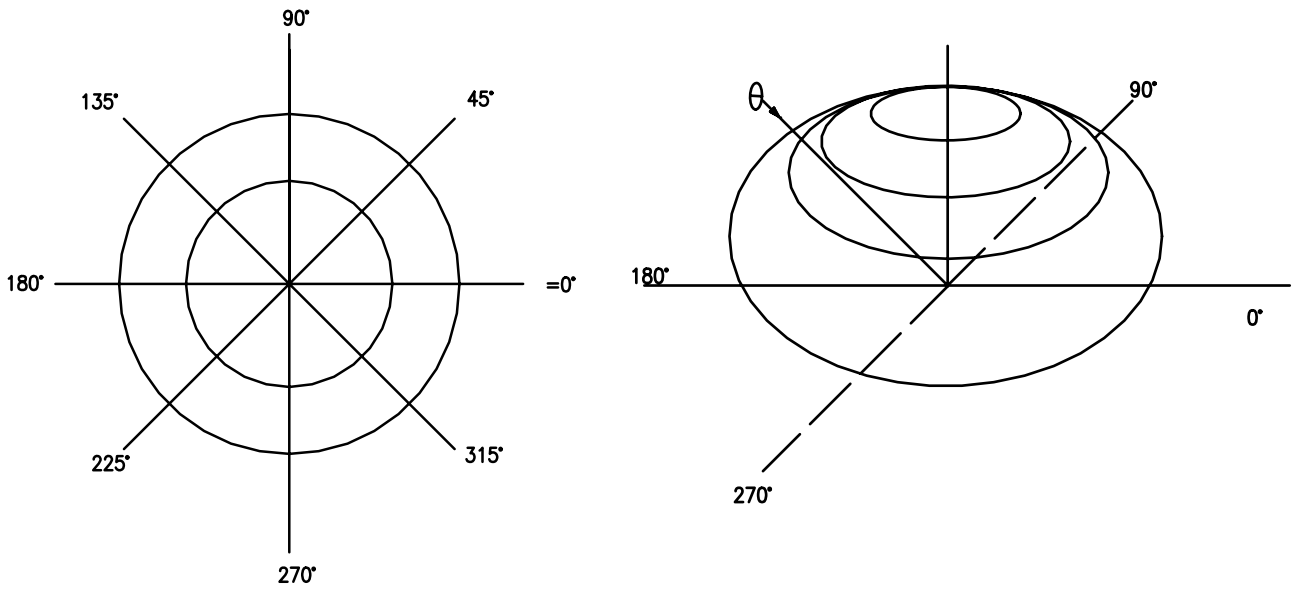

Angular Graph: Contrast Ratio

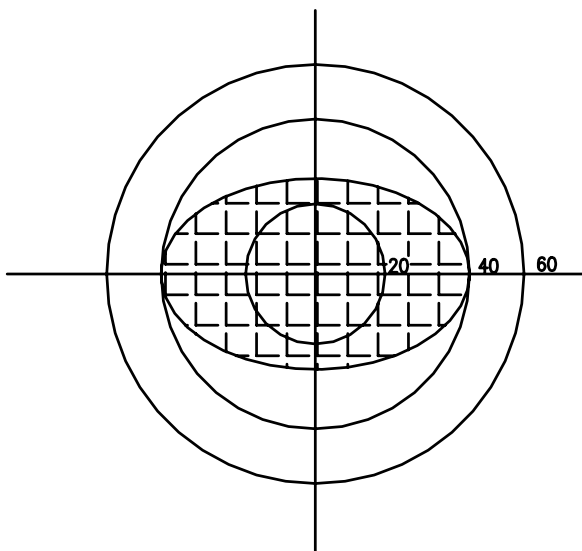

Such as:
 Viewing Angle Range:
 80(Cr>2) Horizontal
 70(Cr>2) Vertical

5. Block Diagram

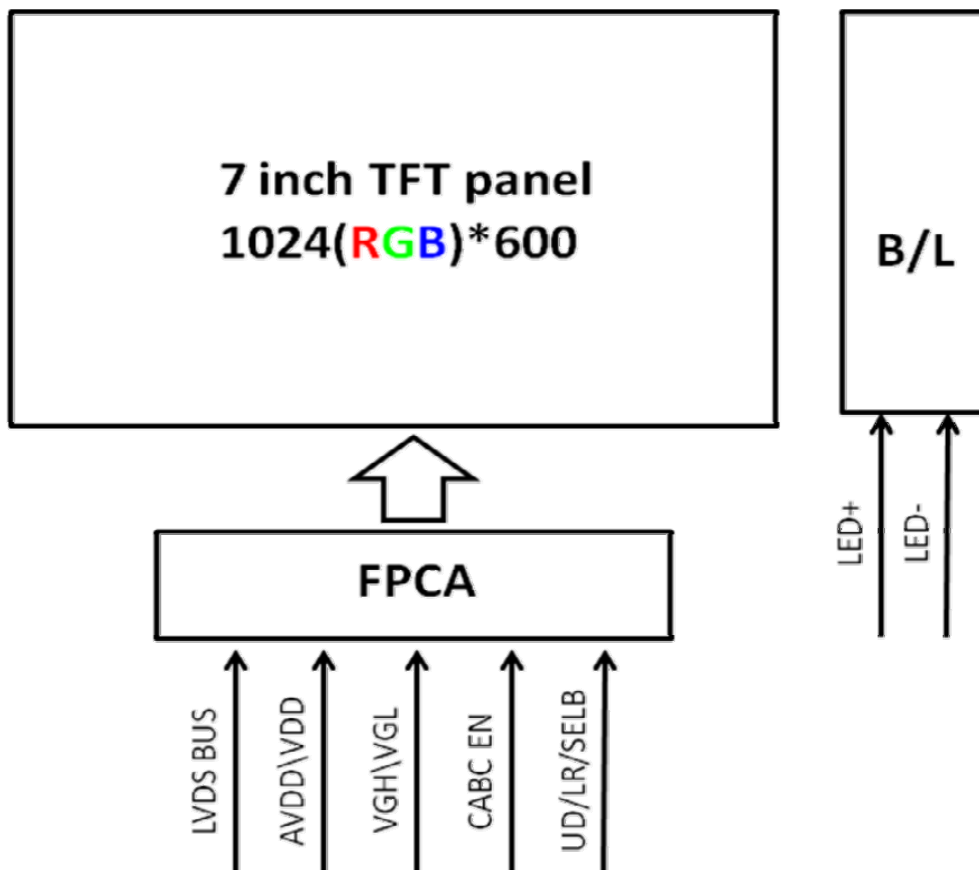

6. Technology Specifications

6.1 Features

This single-display module is suitable for use in Net Book products. The LCD adopts one backlight with High brightness 24-lamps white LED. Construction: 7" a-Si color TFT-LCD ,White LED backlight, FPC and T-CON.

6.2 General Specifications

No.	Item	Specification
1	LCD size	7 inch
2	Resolution	1024 (RGB)X600
3	Display mode	Normally white, Transmissive
4	Pixel pitch	0.150(W)X0.150(H) mm
5	Active area	153.6 (W)X90.0 (H) mm
6	Module size	165.75(W)X105.39(H)X2.85(D)mm
7	Pixel arrangement	RGB-stripe
8	Interface	LVDS
9	Backlight power consumption	1.584W(Typ.)
10	Panel power consumption	TBD
11	Weight	TBD

6.3 Interface Pin Connection

Pin No.	Symbol	I/O	Function	Remarks
1	VCOM	P	Common Voltage	
2	VDD	P	Power Supply,3.3V(typical)	
3	VDD	P	Power Supply,3.3V(typical)	
4	NC	--	No Connection	
5	Reset	I	Global reset pin	
6	STBYB	I	Standby mode ,normally pulled high	Note 1
7	GND	P	Ground	
8	Rin0+	I	-LVDS differential data input(R0-R5,G0)	
9	Rin0+	I	+ LVDS differential data input(R0-R5,G0)	
10	GND	P	Ground	
11	Rin1-	I	- LVDS differential data input(G1-G5,B0-B1)	
12	Rin1+	I	+LVDS differential data input(G1-G5,B0-B1)	
13	GND	P	Ground	
14	Rin2-	I	- LVDS differential data input(B2-B5,HS,VS,DE)	
15	Rin2+	I	+LVDS differential data input(B2-B5,HS,VS,DE)	
16	GND	P	Ground	
17	Rxclk-	I	-LVDS differential clock input	
18	Rxclk+	I	+LVDS differential clock input	
19	GND	P	Ground	
20	Rin3-	I	-LVDS differential data input(R6-R6,G6-G7,B6-B7)	
21	Rin3+	I	-LVDS differential data input(R6-R6,G6-G7,B6-B7)	
22	GND	P	Ground	
23	NC	--	No Connection(Reserve)	
24	NC	--	No Connection(Reserve)	
25	GND	P	Ground	
26	NC	--	No Connection(Reserve)	
27	DIMO	O	Backlight CABC Controller signal output	
28	SELB	I	6bit/8bit mode select	Note 2
29	AVDD	P	Analog power	
30	GND		Ground	
31	LED-	P	LED Cathode	
32	LED-	P	LED Cathode	
33	L/R	I	Horizontal inversion	Note 3
34	U/D	I	Vertical inversion	Note 3
35	VGL	P	Gate off voltage	
36	CABCEN1	I	CABC enable	Note 4
37	CABCEN2	I	CABC enable	Note 4
38	VGH	P	Gate on voltage	
39	LED+	P	LED Anode	
40	LED+	P	Led Anode	

Note 1: STBYB=high ,normally operation; STBYB=low, source driver output .high-Z.

Note 2: If LVDS input data is 6bits,SELB must be set to high;
If LVDS input data is 8bits,SELB must be set to low.

Note 3: L/R&U/D scan direction setting:

Scan control		Scan direction
L/R	U/D	
High	Low	Left to right , up to down
High	High	Left to right , down to up
Low	High	Right to left , down to up
Low	Low	Right to left , up to down

Note 4: Normally pull low.

When CABC_EN="00",CABC OFF;

When CABC_EN="01",user interface image;

When CABC_EN="10",still picture;

When CABC_EN="11",moving image;

When CABC off, don't connect DIMO, else connect it to backlight.

6.4 Absolute Max. Rating

Item	Symbol	Values		Unit
		Min.	Max.	
Power Voltage	VDD	-0.3	4.0	V
	AVDD	6.5	12	V
	VGH	-0.3	20	V
	VGL	-20	0.3	V
Backlight forward current	I _{LED}	0	25	mA(For each LED)
Input Signal Voltage	V _I	-0.3	VDD	
Operation Temperature	T _{OP}	0	50	°C
Storage Temperature	T _{ST}	-20	60	°C

6.5 Typical Operation Conditions

Item	Symbol	Values			Unit
		Min.	Typ.	Max.	
Power Voltage	VDD	3.0	3.3	3.6	V
	AVDD	8.6	8.8	9.0	V
	VGH	17.4	18.4	19.4	V
	VGL	-9	-8	-7	V
	VCOM	2.4	2.6	2.8	V
Power consumption	I _{VDD}	TBD	TBD	TBD	mA
	I _{AVDD}	TBD	TBD	TBD	mA
	I _{LED}	--	160	175	mA

6.6 Power Sequence

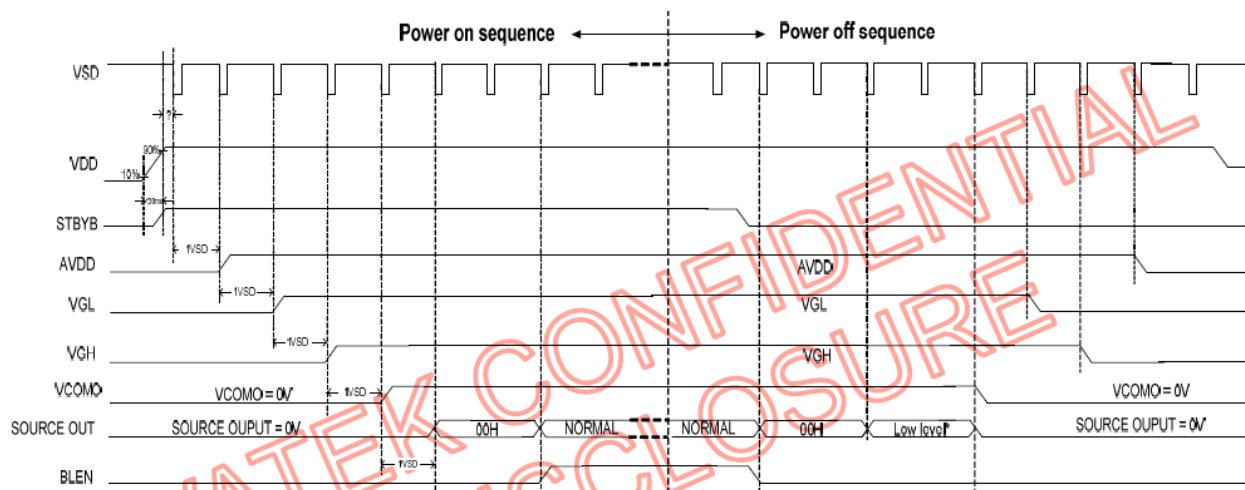

Note: SOURCE OUT includes Rin0- ~ Rin2-, Rin0- ~ Rin2-, Rin0+ ~ Rin2+, CLKIN-, CLKIN+.

6.7 Timing Conditions

Parameter	Symbol	Value			Unit
		Min.	Typ.	Max.	
DCLK frequency @ Frame rate = 60Hz	fclk	40.8	51.2	67.2	MHz
Horizontal display area	thd	1024			DCLK
HSYNC period time	th	1114	1344	1400	DCLK
HSYNC blanking	thb+thfp	90	320	376	DCLK
Vertical display area	tvd	600			H
VSYNC period time	tv	610	635	800	H
VSYNC blanking	tvb+tvfp	10	35	200	H

Timing Diagram

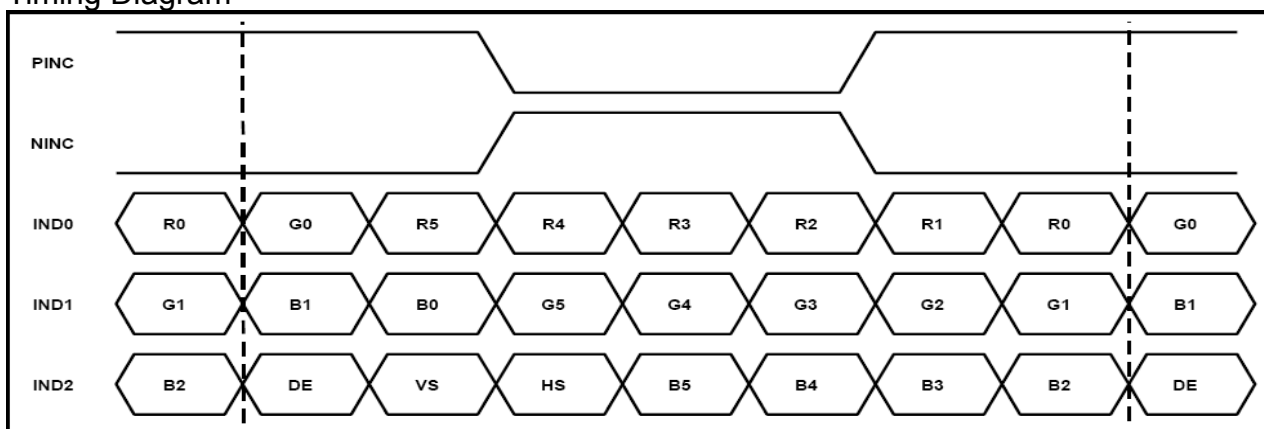

6bits LVDS data input

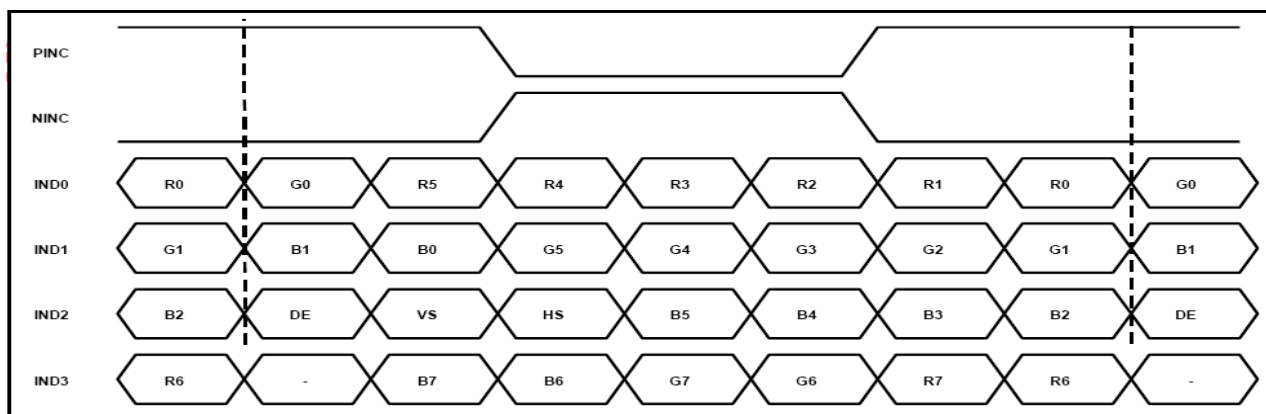

8bits LVDS data input

6.8 Optical specifications

Item	Symbol	Condition	Values			Unit	Remark
			Min.	Typ.	Max.		
Viewing angle (CR ≥ 10)	θ_L	$\Phi=180^\circ$ (9 o'clock)	-	75	-	degree	Note 1
	θ_R	$\Phi=0^\circ$ (3 o'clock)	-	75	-		
	θ_T	$\Phi=90^\circ$ (12 o'clock)	-	75	-		
	θ_B	$\Phi=270^\circ$ (6 o'clock)	-	70	-		
Response time Rise+Fall	T_{RT}	Normal $\theta=\Phi=0^\circ$	-	20	30	msec	Note 3
Contrast ratio	CR		400	500	-	-	Note 4
Color chromaticity	W_X		0.26	0.31	0.36	-	Note 2
	W_Y		0.28	0.33	0.38	-	Note 5 Note 6
Luminance	L		200	250	-	-	Note 6
Luminance uniformity	Y_U		70	75	-	%	Note 6,7

Note 1: Definition of viewing angle range

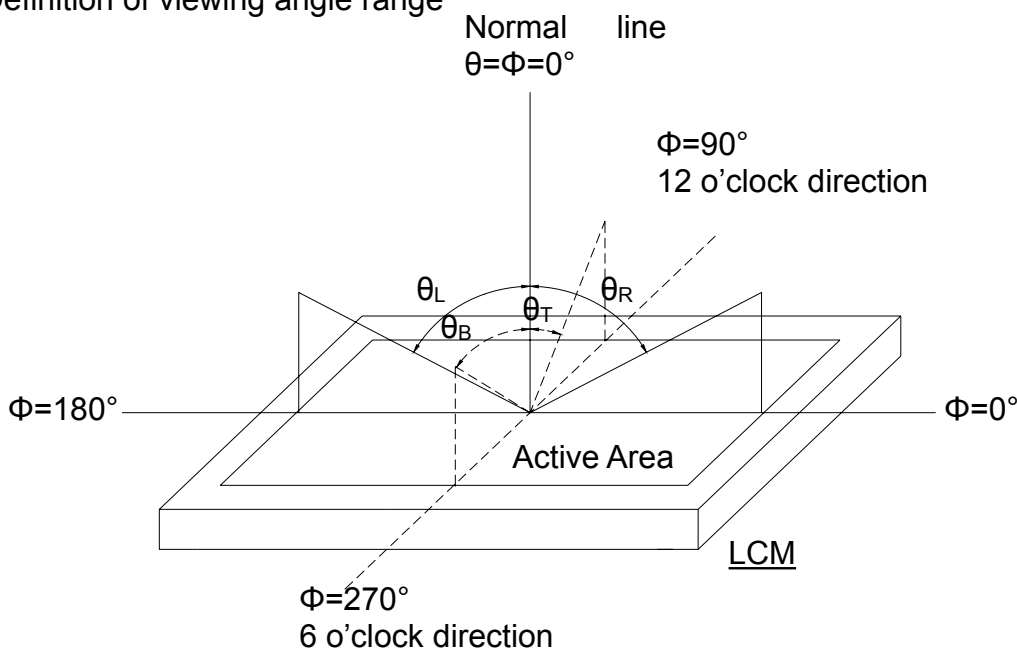

Fig. 4-1 Definition of viewing angle

Note 2: Definition of optical measurement system.

The optical characteristics should be measured in dark room. After 30 minutes operation, the optical properties are measured at the center point of the LCD screen. (Viewing angle is measured by ELDIM-EZ contrast/Height :1.2mm ,Response time is measured by Photo detector TOPCON BM-7, other items are measured by BM-5A/Field of view: 1° /Height: 500mm.)

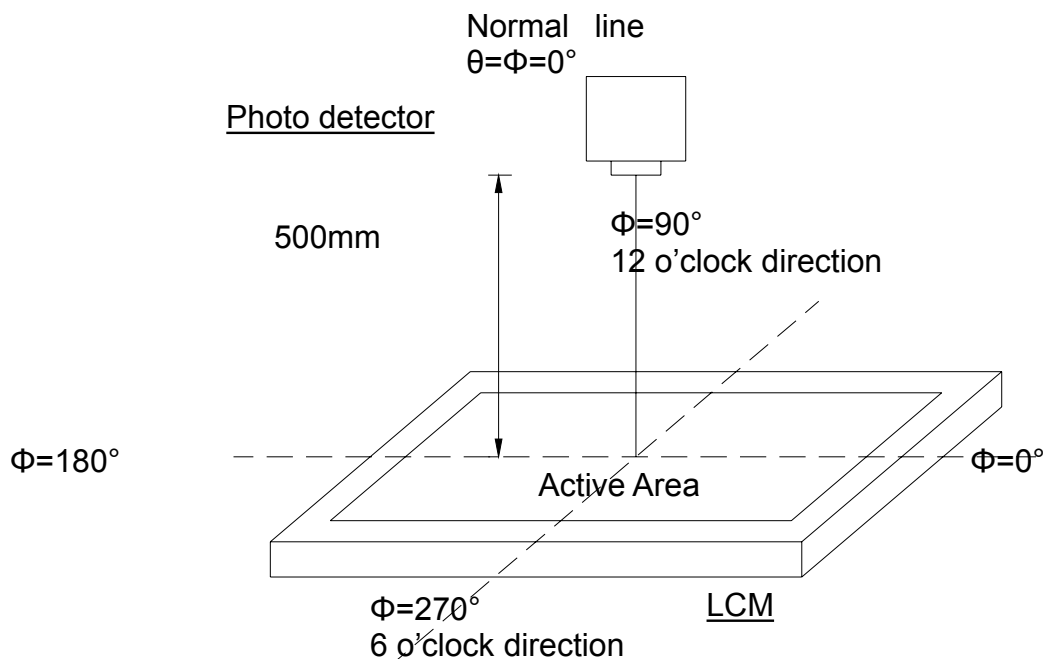

Fig. 4-2 Optical measurement system setup

Note 3: Definition of Response time

The response time is defined as the LCD optical switching time interval between "White" state and "Black" state. Rise time (T_{ON}) is the time between photo detector output intensity changed from 90% to 10%. And fall time (T_{OFF}) is the time between photo detector output intensity changed from 10% to 90%.

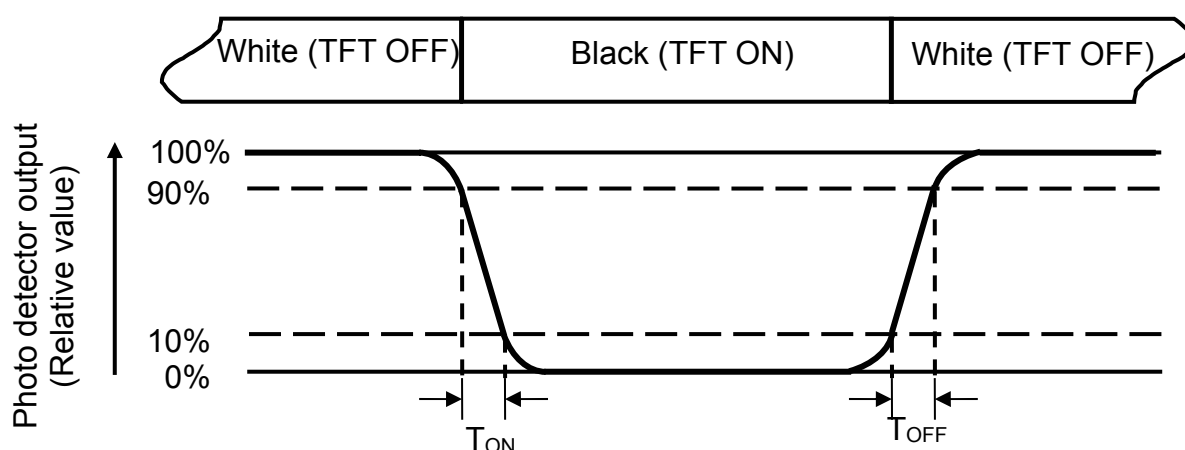

Fig. 4- 3 Definition of response time

Note 4: Definition of contrast ratio

$$\text{Contrast ratio (CR)} = \frac{\text{Luminance measured when LCD on the "White" state}}{\text{Luminance measured when LCD on the "Black" state}}$$

Note 5: Definition of color chromaticity (CIE1931)
 Color coordinates measured at center point of LCD.

Note 6: All input terminals LCD panel must be ground while measuring the center area of the panel. The LED driving condition is $V_{LED}=5.0V$.
 Note 7: Definition of Luminance Uniformity

Active area is divided into 9 measuring areas (Refer to Fig. 4-4).Every measuring point is placed at the center of each measuring area.

$$\text{Luminance Uniformity (Yu)} = \frac{B_{min}}{B_{max}}$$

L-----Active area length W----- Active area width

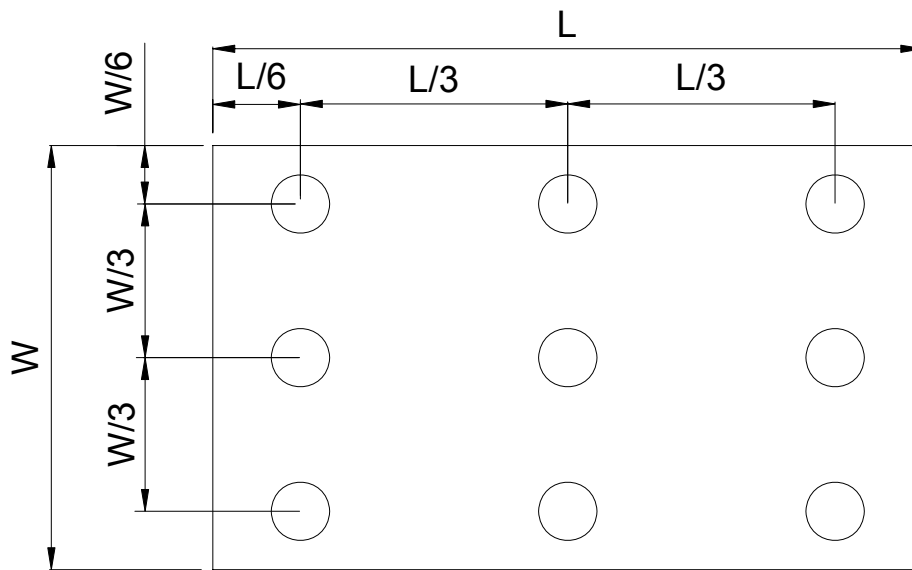

Fig. 4- 4 Definition of measuring points

B_{max} : The measured maximum luminance of all measurement position.
 B_{min} : The measured minimum luminance of all measurement position.

7. Reliability Test Conditions And Methods

Item	Test Conditions	Remark
High Temperature Storage	Ta = 70°C 240 hrs	
Low Temperature Storage	Ta = -20°C 240hrs	
High Temperature Operation	Ts = 60°C 240hrs	
Low Temperature Operation	Ta = -10°C 240hrs	
Operate at High Temperature and Humidity	+60°C, 90%RH max. 240 hrs	Operation
Thermal Shock	-20°C~ +70°C 100 cycles 2Hrs/cycle	Non-operation
Electrostatic Discharge	Contact=±4KV, class B Air=±8KV, class B	

8. Handling Precautions

8.1 Mounting method

The LCD panel of Daxian LCD module consists of two thin glass plates with polarizers which easily be damaged. And since the module is so constructed as to be fixed by utilizing fitting holes in the printed circuit board.

Extreme care should be needed when handling the LCD modules.

8.2 Caution of LCD handling and cleaning

When cleaning the display surface, Use soft cloth with solvent [recommended below] and wipe lightly

- Isopropyl alcohol
- Ethyl alcohol

Do not wipe the display surface with dry or hard materials that will damage the polarizer surface.

Do not use the following solvent:

- Water
- Aromatics

Do not wipe ITO pad area with the dry or hard materials that will damage the ITO patterns

Do not use the following solvent on the pad or prevent it from being contaminated:

- Soldering flux
- Chlorine (Cl) , Sulfur (S)

If goods were sent without being sili8con coated on the pad, ITO patterns could be damaged due to the corrosion as time goes on.

If ITO corrosion happens by miss-handling or using some materials such as Chlorine (Cl), Sulfur (S) from customer, Responsibility is on customer.

8.3 Caution against static charge

The LCD module uses C-MOS LSI drivers, so we recommend that you:

Connect any unused input terminal to Vdd or Vss, do not input any signals before power is turned on, and ground your body, work/assembly areas, assembly equipment to protect against static electricity.

8.4 packing

- Module employs LCD elements and must be treated as such.
- Avoid intense shock and falls from a height.
- To prevent modules from degradation, do not operate or store them exposed direct to

sunshine or high temperature/humidity

8.5 Caution for operation

- It is an indispensable condition to drive LCD's within the specified voltage limit since the higher voltage than the limit causes the shorter LCD life.
- An electrochemical reaction due to direct current causes LCD's undesirable deterioration, so that the use of direct current drive should be avoided.
- Response time will be extremely delayed at lower temperature than the operating temperature range and on the other hand at higher temperature LCD's show dark color in them. However those phenomena do not mean malfunction or out of order with LCD's, which will come back in the specified operation temperature.
- If the display area is pushed hard during operation, some font will be abnormally displayed but it resumes normal condition after turning off once.
- A slight dew depositing on terminals is a cause for electro-chemical reaction resulting in terminal open circuit.
Usage under the maximum operating temperature, 50%Rh or less is required.

8.6 storage

In the case of storing for a long period of time for instance, for years for the purpose of replacement use, the following ways are recommended.

- Storage in a polyethylene bag with the opening sealed so as not to enter fresh air outside in it. And with no desiccant.
- Placing in a dark place where neither exposure to direct sunlight nor light's keeping the storage temperature range.
- Storing with no touch on polarizer surface by anything else.
[It is recommended to store them as they have been contained in the inner container at the time of delivery from us]

8.7 Safety

- It is recommendable to crash damaged or unnecessary LCD's into pieces and wash off liquid crystal by either of solvents such as acetone and ethanol, which should be burned up later.
- When any liquid leaked out of a damaged glass cell comes in contact with your hands, please wash it off well with soap and water

9. Precaution for use

9.1

A limit sample should be provided by the both parties on an occasion when the both parties agreed its necessity. Judgment by a limit sample shall take effect after the limit sample has been established and confirmed by the both parties.

9.2

On the following occasions, the handing of problem should be decided through discussion and agreement between responsible of the both parties.

- When a question is arisen in this specification
- When a new problem is arisen which is not specified in this specifications
- When an inspection specifications change or operating condition change in customer is reported to Daxian, and some problem is arisen in this specification due to the change
- When a new problem is arisen at the customer's operating set for sample evaluation in the customer site.

10. Package Drawing

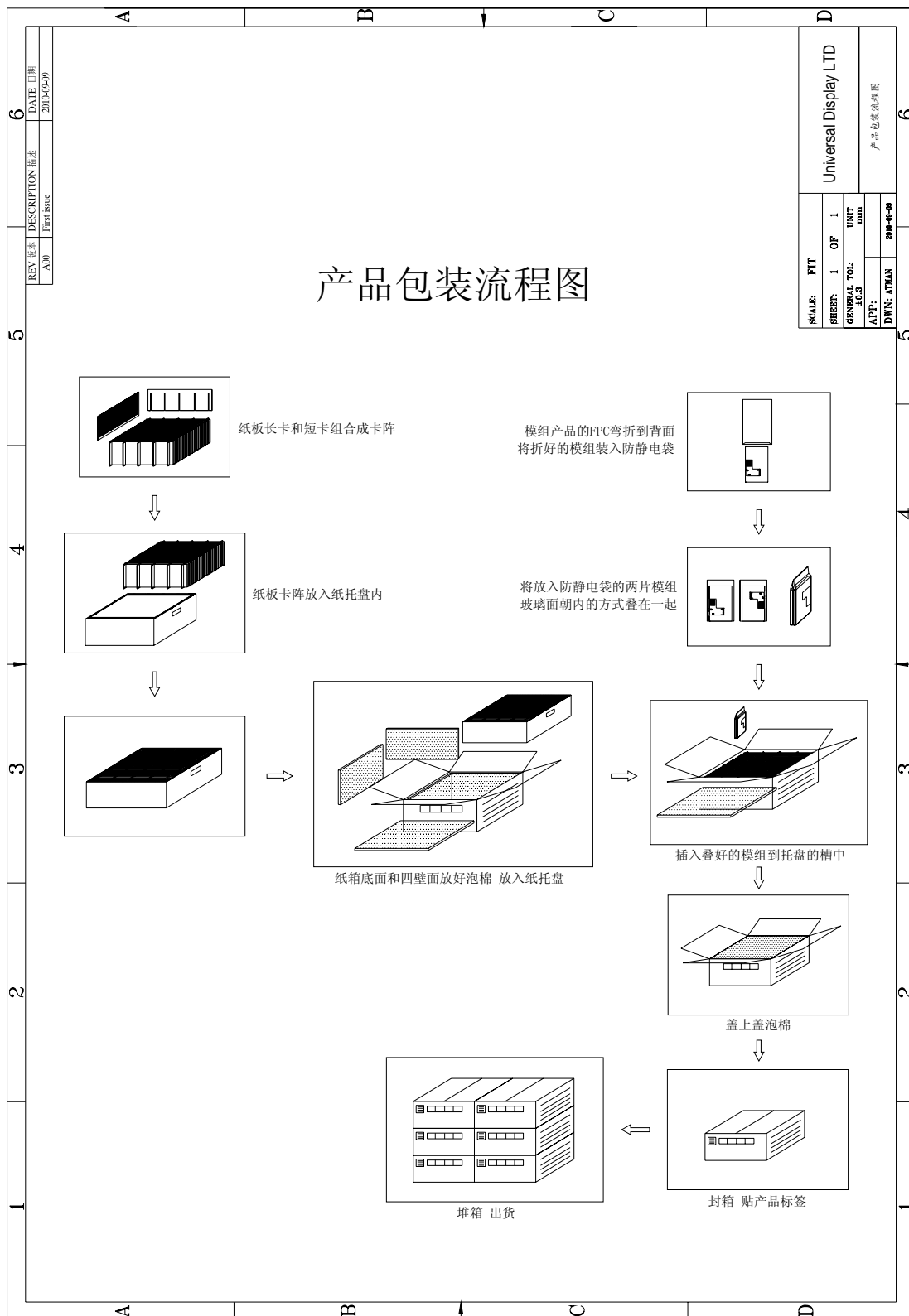

Note:

Total LCM quantity of per carton is 120pcs.

11. Outline Dimension

