



Universal Display LTD

SPECIFICATION FOR LCD MODULE

Customer : _____

Product Model: KD070D10-50NB-A5

Sample code: _____

Designed by	Checked by	Approved by

Final Approval by Customer

<input type="checkbox"/> LCM Machinery OK Checked By _____	<input type="checkbox"/> LCM OK
<input type="checkbox"/> LCM Display OK Checked By _____	<input type="checkbox"/> NG, Problem survey: Approved By _____

※The specification of "TBD" should refer to the measured value of sample . If there is difference between the design specification and measured value, we naturally shall negotiate and agree to solution with customer.

Contents

No.	Item	Page
1.	Numbering System	4/26
2	Scope	5/26
3	Normative Reference	5/26
4	Definitions	5/26
5	Technology Specifications	7/26
6	Circuit block diagram	14/26
7	Reliability Test Condition and Methods	16/26
8	Inspection standard	17/26
9	Handling Precautions	23/26
10	Precaution for use	24/26
11	Dimensional Outline	25/26
12	Packaging Drawing	26/26

1 Numbering System

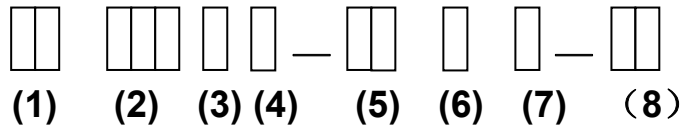

No	Definition	Specifications
(1)	TFT LCM Productor No.	KD
(2)	Display monitor opposite angle line size	Unit :mm or mmm (size <10 inch: takes two integers ; size >=10 inch: takes three integers)
(3)	Productor Types	D ---- Digital photo frame / DVD G ----GPS M ----MP P ----Mobil-Phone o o o
(4)	Productor Development Series No.	By two figures characters expression from 01 to 99
(5)	Interface PIN Number	By two figures characters expression from 01 to 99
(6)	With Touch Panel Or Not	T----With T/P ; N----Without T/P
(7)	LCD Type	A----AUO ; M----CMO ; C----CPT; P----PVI; L----LG; W----Wintek; H----HSD; T----Topply; Y----Hydis; I----INNOLUX; S----Sharp
(8)	Productor Development edition No.	By The English litters : A 1~ Z9

2 Scope

3 Normative Reference

GB/T4619-1996 《Liquid Crystal Display Test Method》

GB/T2424 《Basic environmental Testing Procedures for Electric and Electronic Products.》

GB/T2423 《Basic Testing Procedures for Electric and Electronic Products》

IEC61747-1 《SIXTH PART GB2828`2829-87 《National Standard of PRC》

4 Definitions

4.1 Definitions of Vop

The definitions of threshold voltage V_{th1} , V_{th2} the following typical waveforms are applied on liquid crystal by the method of equalized voltage for each duty and bias.

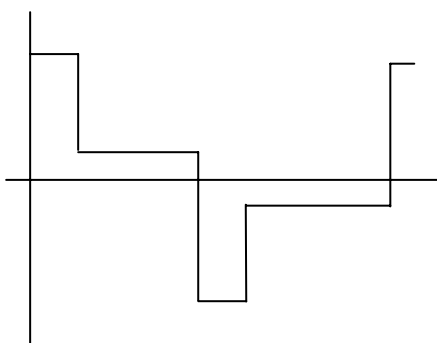

【 selected waveform 】

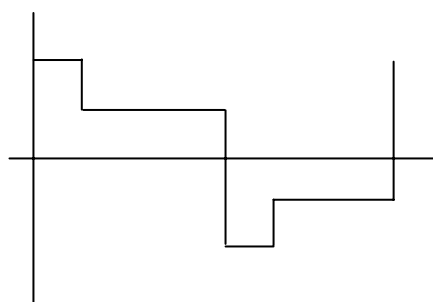

【 non-selected waveform 】

① V_{th1} : The voltage which the brightness of segment indicates 50% of saturated value on the conditions of selected waveform
($f_r=80\text{Hz}$, $\Phi=10^\circ$ $\theta=270^\circ$ at 25°C)

② V_{th2} : The voltage which the brightness of segment indicates 50% of saturated value on the conditions of non-selected waveform
($f_r=80\text{Hz}$, $\Phi=10^\circ$ $\theta=270^\circ$ at 25°C)

③ V_{op} : $(V_{th1}(50\%)+V_{th2}(50\%))/2$ ($f_r=80\text{Hz}$, $\Phi=10^\circ$ $\theta=270^\circ$ at 25°C)

4.2 Definition of Response Time T_r , T_d

① T_r : The time required which the brightness of segment becomes 10% from 100% when waveform is switched to selected one from non-selected one. ($f_r=80\text{Hz}$, $\Phi=10^\circ$ $\theta=270^\circ$ at 25°C)

② T_d : The time required which the brightness of segment becomes 90% from 10% when waveform is switched to

selected one from selected one. ($f_r=80\text{Hz}$, $\Phi=10^\circ$ $\theta=270^\circ$ at 25°C)

4.3 Definition of Contrast Ratio Cr

$Cr=A/B$

- ① A: Segments brightness in case of non-selected waveform
- ② B: Segments brightness in case of selected waveform

4.4 Definition of Angle and Viewing Range

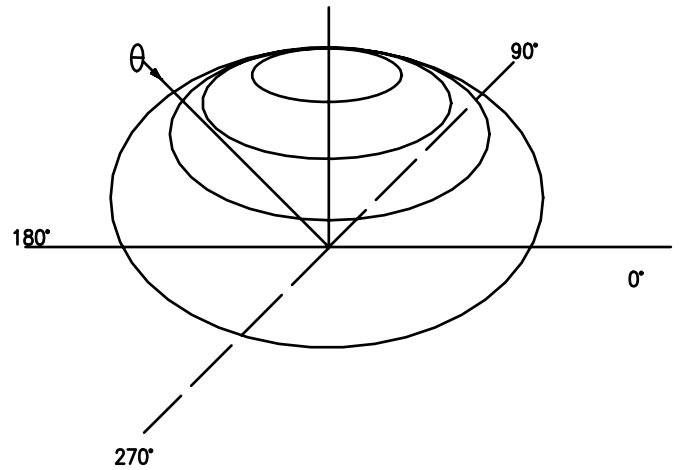
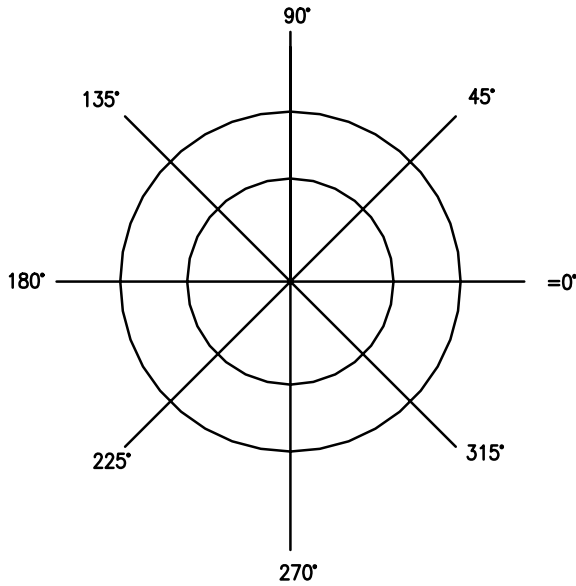

Angular Graph: Contrast Ratio

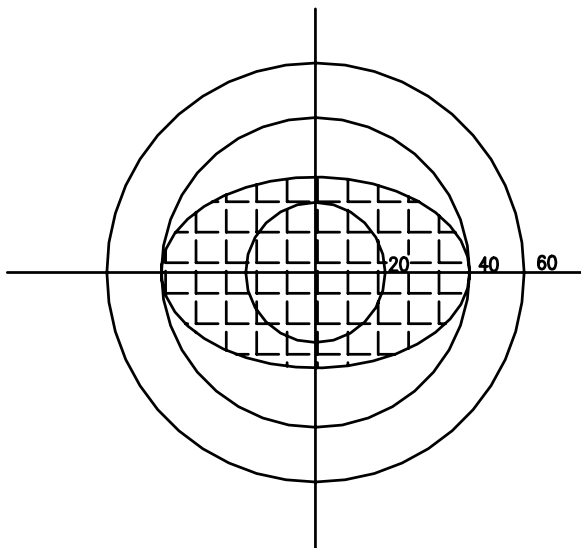

Such as:
 Viewing Angle Range:
 80($Cr>2$) Horizontal
 70($Cr>2$) Vertical

5 Technology Specifications

5.1 Feature

This single-display module is suitable for use in Multimedia Player products. The LCD adopts one backlight with High brightness 12-lamps white LED.

- 1) Construction: 7" a-Si color TFT-LCD ,White LED backlight and FPC.
- 2) LCD:
 - 2.1 Amorphous-TFT 7-inch display, transmissive, normally white type.
 - 2.2 800(RGB)×480 dots Matrix.
 - 2.3 Narrow-contact ledge technique.
- 3) RGB interface.
- 4) Video signal interface: Parallel RGB.

5.2 Mechanical Specifications

Item	Specifications	Unit
Dimensional outline	164.9(W) ×100.0(H) ×3.4(D)	mm
Active area	154.08(W) × 85.92(H)	mm
Pixel size	63.2(W) ×RGB×179(H)	um
Resolution	800(RGB) ×480	pixel
Luminance	200 (TYP)	cd/m2

5.3 Absolute Max. Rating

Item	Symbol	Values		Unit	Remark
		Min.	Max		
Power voltage	DV _{DD}	-0.5	5.0	V	
	AV _{DD}	-0.5	15	V	
	V _{GH}	-0.3	40	V	
	V _{GL}	-20	0.3	V	
Operation temperature	T _{OP}	-10	60	°C	
Storage temperature	T _{ST}	-20	70	°C	

Note: The absolute maximum rating values of this product not allowed to be exceeded at any times. Should be module be used with any of absolute maximum ratings exceeded. The characteristics of the module may not be recovered, or in an extreme case, the module may be permanently destroyed.

5.4 Electrical Characteristics

Note 1

Item	Symbol	Values			Unit	Remark
		Min.	Typ	Max		
Power voltage	DV_{DD}	3.0	3.3	3.6	V	Note 2
	AV_{DD}	10.1	10.3	10.5	V	
	V_{GH}	17.5	18	18.5	V	
	V_{GL}	-8.5	-8	-7.5	V	
Input signal voltage	V_{COM}	3.1	3.3	3.4	V	
Input logic high voltage	V_{IH}	$0.7DV_{DD}$	-	DV_{DD}	V	Note 3
Input logic low voltage	V_{IL}	0	-	$0.3DV_{DD}$	V	

Note 1: Be sure to apply DV_{DD} and V_{GL} to the LCD first, and then apply V_{GH} .

Note 2: DV_{DD} setting should match the signals output voltage (refer to Note 3) of Customer's system board.

Note 3: DCLK, HS.VS, RESET, U/D, L/R, DE, R0-R7, G0-G7, G0-G7, MODE, DITHB.

5.5 Optical specifications

Item	Symbol	Condition	Values			Unit	Remark
			Min.	Typ.	Max.		
Viewing angle ($CR \geq 10$)	θ_L	$\Phi = 180^\circ$ (9 o'clock)	70	80	-	degree	Note 1
	θ_R	$\Phi = 0^\circ$ (3 o'clock)	70	80	-		
	θ_T	$\Phi = 90^\circ$ (12 o'clock)	60	70	-		
	θ_B	$\Phi = 270^\circ$ (6 o'clock)	65	75	-		
Response time	T_{ON}	Normal $\theta = \Phi = 0^\circ$	-	10	20	msec	Note 3
	T_{OFF}		-	15	30	msec	Note 3
Contrast ratio	CR		350	500	-	-	Note 4
Color chromaticity	W_X		0.249	0.299	0.349	-	Note 2
	W_Y		0.281	0.331	0.381	-	Note 5 Note 6
Luminance	L		180	200	-	cd/m ²	Note 6
Luminance uniformity	Y_U		70	80	-	%	Note 6,7

Test Conditions:

1. $DV_{DD} = 3.3V$, $I_{LED} = 120mA$, the ambient temperature is $25^\circ C$.
2. The test systems refer to Note 2.

Note 1: Definition of viewing angle range

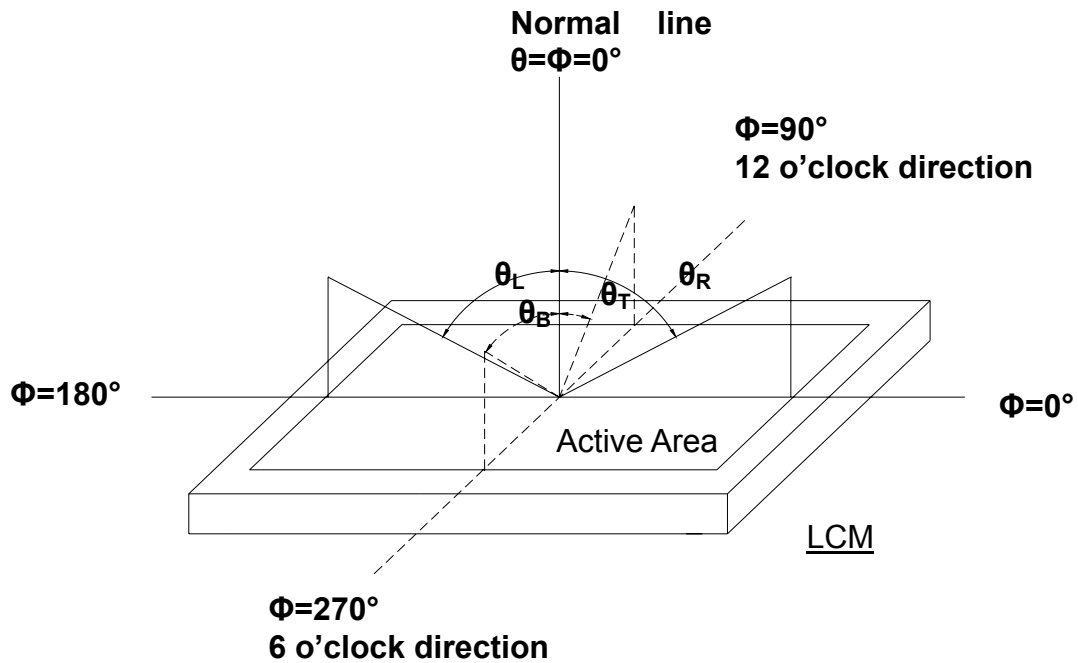

Note 2: Definition of optical measurement system.

The optical characteristics should be measured in dark room. After 30 minutes operation, the optical properties are measured at the center point of the LCD screen. (Viewing angle is measured by ELDIM-EZ contrast/Height :1.2mm ,Response time is measured by Photo detector TOPCON BM-7, other items are measured by BM-5A/ Field of view: 1° /Height: 500mm.)

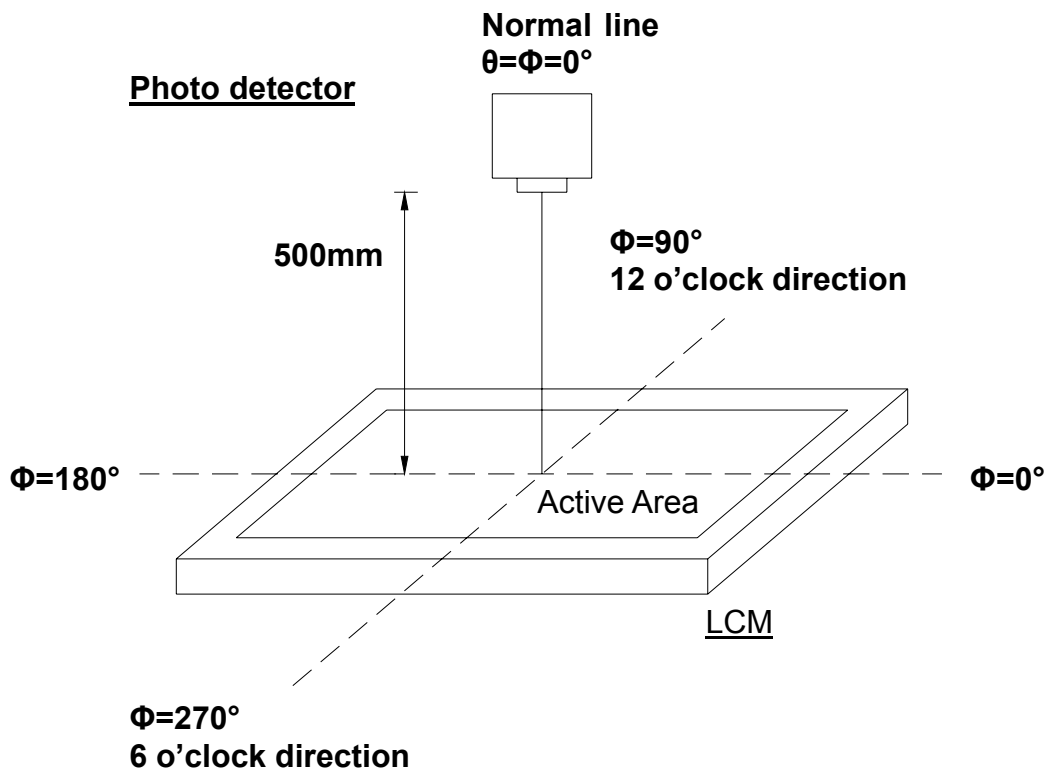

Note 3: Definition of Response time

The response time is defined as the LCD optical switching time interval between "White" state and "Black" state. Rise time (T_{ON}) is the time between photo detector output intensity changed from 90% to 10%. And fall time (T_{OFF}) is the time between photo detector output intensity changed from 10% to 90%.

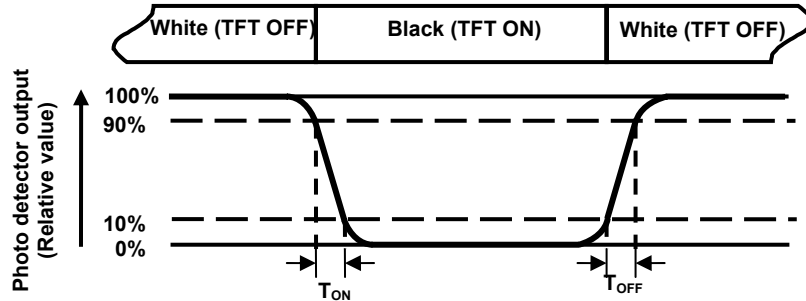

Note 4: Definition of contrast ratio

$$\text{Contrast ratio (CR)} = \frac{\text{Luminance measured when LCD on the "White" state}}{\text{Luminance measured when LCD on the "Black" state}}$$

Note 5: Definition of color chromaticity (CIE1931)

Color coordinates measured at center point of LCD.

Note 6: All input terminals LCD panel must be ground while measuring the center area of the panel. The LED driving condition is $I_{LED}=180\text{mA}$.

Note 7: Definition of Luminance Uniformity

Active area is divided into 9 measuring areas. Every measuring point is placed at the center of each measuring area.

$$\text{Luminance Uniformity (Yu)} = \frac{B_{min}}{B_{max}}$$

L-----Active area length W----- Active area width

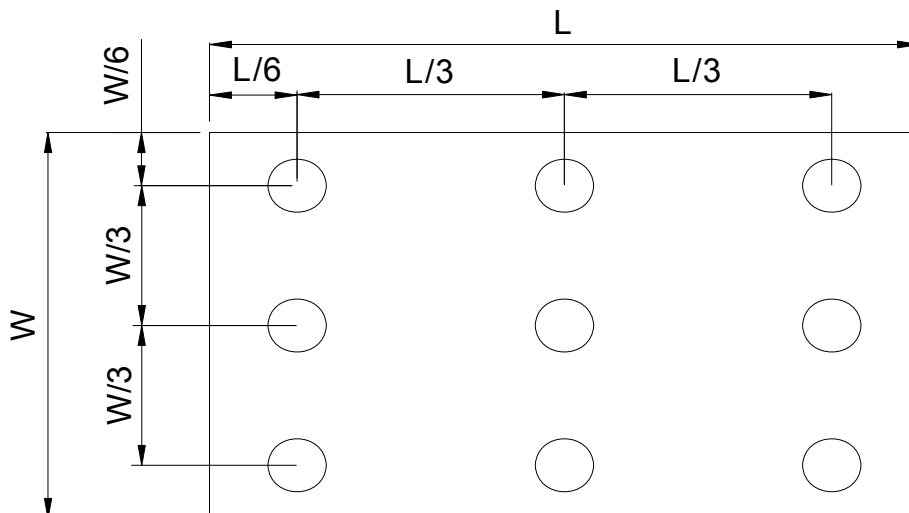

B_{max} : The measured maximum luminance of all measurement position.

B_{min} : The measured minimum luminance of all measurement position.

5.6 LED back light specification (12 White Chips)

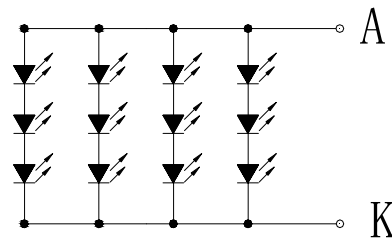

5.7 Interface Pin Connections

Pin No.	Symbol	I/O	Function	Remark
1	VLED+	P	Power for LED Backlight(Anode)	
2	VLED+	P	Power for LED Backlight(Anode)	
3	VLED-	P	Power for LED Backlight(Cathode)	
4	VLED-	P	Power for LED Backlight(Cathode)	
5	GND	P	Power ground	
6	V _{COM}	I	Common voltage	
7	DV _{DD}	P	Power for Digital Circuit	
8	MODE	I	DE/SYNC mode select	Note 1
9	DE	I	Data Input Enable	
10	VS	I	Vertical Sync Input	
11	HS	I	Horizontal Sync Input	
12	B7	I	Blue data(MSB)	
13	B6	I	Blue data	
14	B5	I	Blue data	
15	B4	I	Blue data	
16	B3	I	Blue data	
17	B2	I	Blue data	
18	B1	I	Blue data	Note 2
19	B0	I	Blue data(LSB)	Note 2
20	G7	I	Green data(MSB)	
21	G6	I	Green data	
22	G5	I	Green data	
23	G4	I	Green data	
24	G3	I	Green data	
25	G2	I	Green data	

26	G1	I	Green data	Note 2
27	G0	I	Green data(LSB)	Note 2
28	R7	I	Red data(MSB)	
29	R6	I	Red data	
30	R5	I	Red data	
31	R4	I	Red data	
32	R3	I	Red data	
33	R2	I	Red data	
34	R1	I	Red data	Note 2
35	R0	I	Red data(LSB)	Note 2
36	GND	P	Power Ground	
37	DCLK	I	Sample clock	Note 3
38	GND	P	Power Ground	
39	L/R	I	Left / right selection	Note 4,5
40	U/D	I	Up/down selection	Note 4,5
41	V _{GH}	P	Gate ON Voltage	
42	V _{GL}	P	Gate OFF Voltage	
43	AV _{DD}	P	Power for Analog Circuit	
44	RESET	I	Global reset pin.	Note 6
45	NC	-	No connection	
46	V _{COM}	I	Common Voltage	
47	DITHB	I	Dithering function	Note 7
48	GND	P	Power Ground	
49	NC	-	No connection	
50	NC	-	No connection	

I: input, O: output, P: Power

Note 1: DE/SYNC mode select. Normally pull high.

When select DE mode, MODE="1", VS and HS must pull high.

When select SYNC mode, MODE="0", DE must be grounded.

Note 2: When input 18 bits RGB data, the two low bits of R,G and B data must be grounded.

Note 3: Data shall be latched at the falling edge of DCLK.

Note 4: Selection of scanning mode

Setting of scan control input		Scanning direction
U/D	L/R	
GND	DV _{DD}	Up to down, left to right

DV _{DD}	GND	Down to up, right to left
GND	GND	Up to down, right to left
DV _{DD}	DV _{DD}	Down to up, left to right

Note 5: Definition of scanning direction.
Refer to the figure as below:

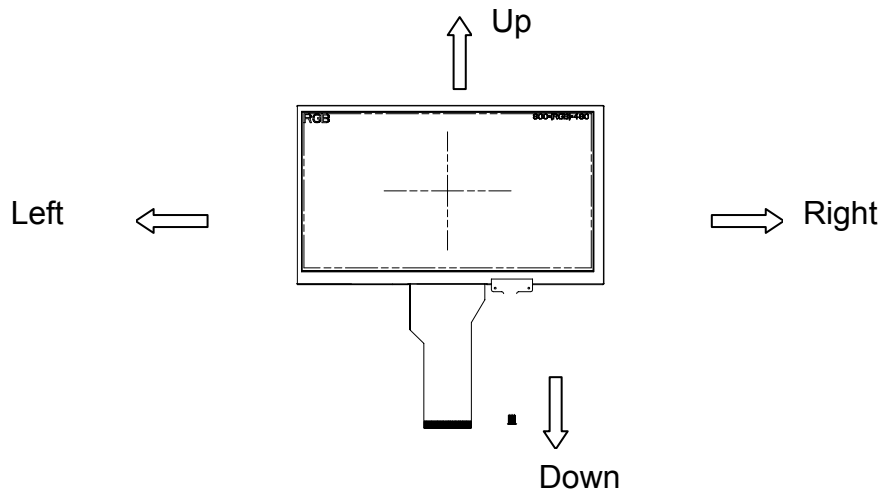

Note 6: Global reset pin. Active low to enter reset state. Suggest to connect with an RC reset circuit for stability. Normally pull high.

Note 7: Dithering function enable control, normally pull high.
When DITHB="1", Disable internal dithering function,
When DITHB="0", Enable internal dithering function,

6 Signal timing diagram

6.2 Signal Timing Diagram

6.2.1 Power ON/OFF Sequence

a Power on

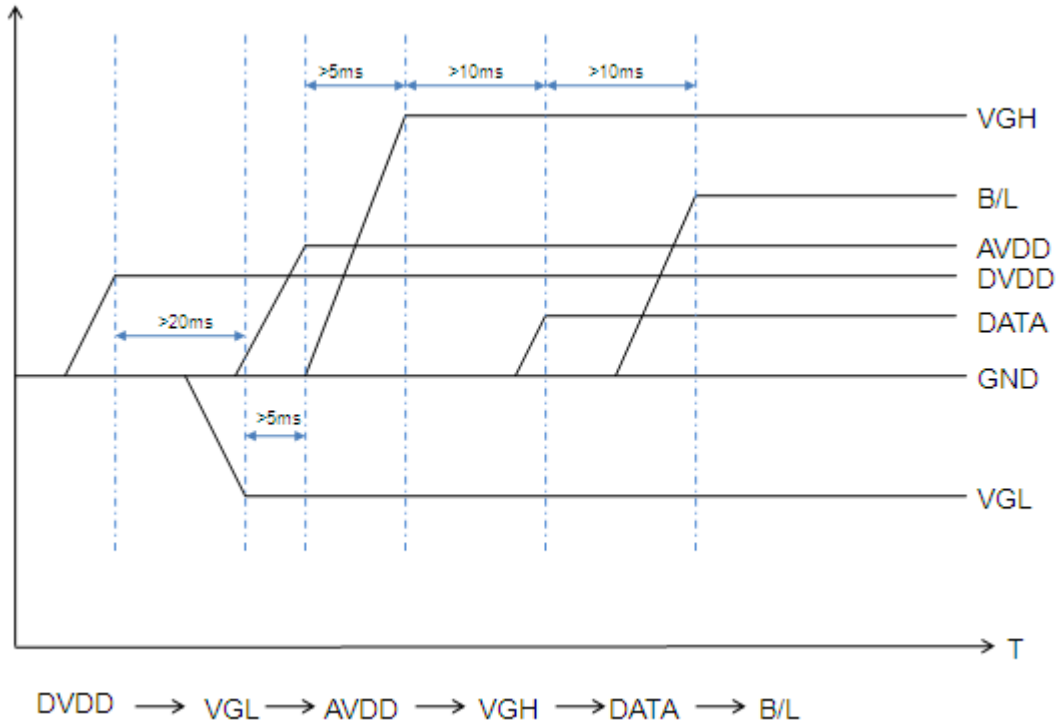

b Power off

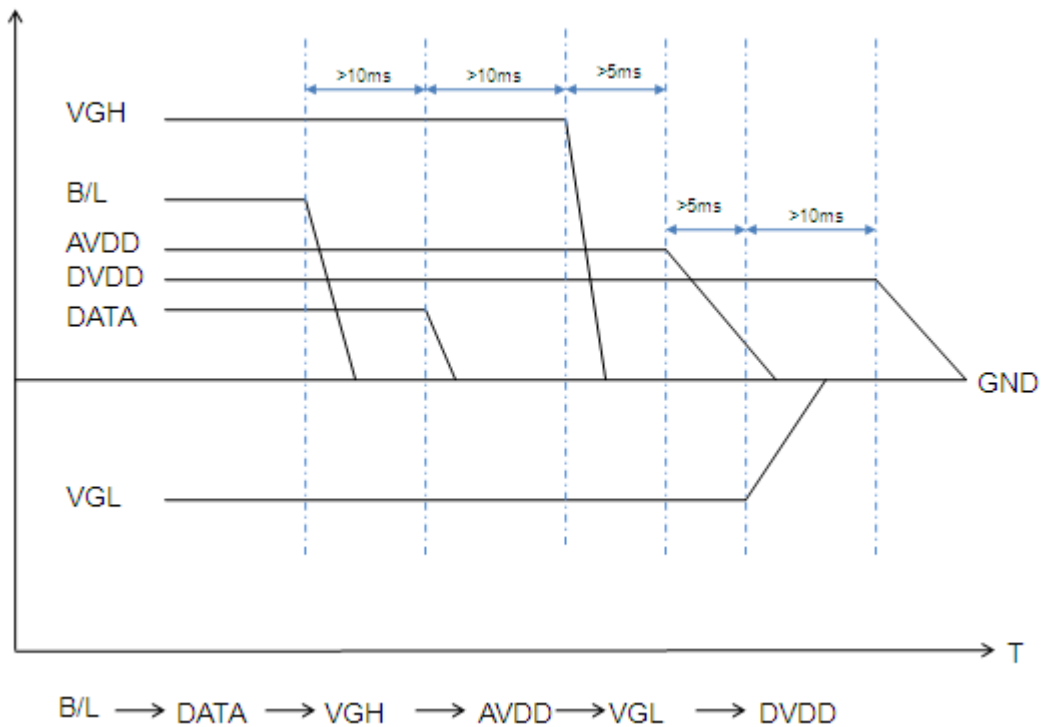

6.2.2 Data input format

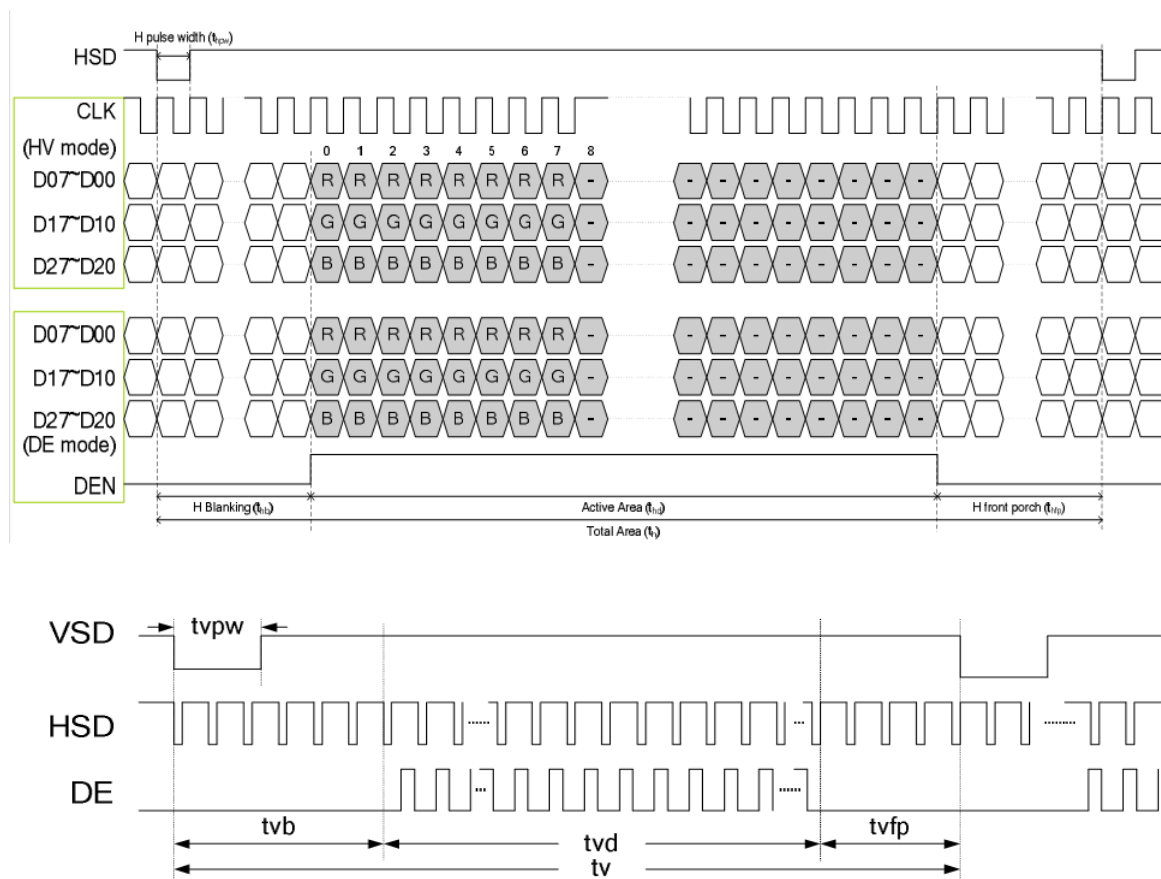

6.2.3 Timing Diagram

Item	Symbol	Values			Unit	Remark
		Min	Typ	Max		
Horizontal Display Area	thd	-	800	-	DCLK	
DCLK frequency	fck	-	30	50	MHz	
One horizontal line	th	889	928	1143	DCLK	
HS pulse width	thpw	1	48	255	DCLK	
HS Blanking	thb	88	88	88	DCLK	
HS Front Porch	thfp	1	40	255	DCLK	

Item	Symbol	Values			Unit	Remark
		Min	Typ	Max		
Vertical display Area	tvd	-	480	-	TH	
VS period time	tv	513	525	767	TH	
VS pulse width	tvpw	3	3	255	TH	
VS Blanking	tvb	32	32	32	TH	
VS Front Porch	tvfp	1	13	255	TH	

7 Reliability Test Conditions And Methods

NO	Item	Condition	Method
1	High / Low Temperature Storage	70°C/-20°C 120hrs	Check and record every 48Hrs
2	High / Low Temperature Life	60°C/-10°C 120hrs (operating mode)	Check and record every 48Hrs
3	High Temperature、High Humidity Operating	60°C,90% RH, 96Hrs	Check and record every 48hrs
4	Thermal Shock	-20°C(30Min) → 25°C(5Min) → 70°C(30Min) (conversion time, : 5 sec) 20 cycles	Each 10 cycles end , check
5	Static Electricity	Gap mood: ±1KV~±8KV (10 times air discharge with positive/negative voltage voltage gap : 1kv) Touch mood: ±1KV~±4KV	Each discharge end, Check the Electrical Characteristics

8 Inspection standard

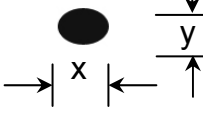
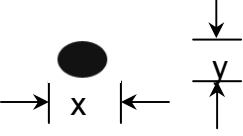
No	Item	Criterion									
01	Outline Dimension	In accord with drawing									
02	Position-finding Dimension Assemble Dimension	In accord with drawing									
03	LCD black spots, white spots (Round type)	Round type: non display 3.1 Small area LCD Unit : mm  <table border="1" data-bbox="774 750 1300 1064"> <thead> <tr> <th>Dimension</th> <th>Qualified Quantity</th> </tr> </thead> <tbody> <tr> <td>$D \leq 0.1$</td> <td>Ignore</td> </tr> <tr> <td>$0.1 < D \leq 0.15$</td> <td>2</td> </tr> <tr> <td>$D > 0.15$</td> <td>0</td> </tr> </tbody> </table>	Dimension	Qualified Quantity	$D \leq 0.1$	Ignore	$0.1 < D \leq 0.15$	2	$D > 0.15$	0	
		Dimension	Qualified Quantity								
$D \leq 0.1$	Ignore										
$0.1 < D \leq 0.15$	2										
$D > 0.15$	0										
3.2 Large area LCD  <table border="1" data-bbox="774 1243 1300 1624"> <thead> <tr> <th>Dimension</th> <th>Qualified Quantity</th> </tr> </thead> <tbody> <tr> <td>$D \leq 0.1$</td> <td>Ignore</td> </tr> <tr> <td>$0.1 < D \leq 0.15$</td> <td>2</td> </tr> <tr> <td>$0.15 < D \leq 0.20$</td> <td>1</td> </tr> <tr> <td>$D > 0.20$</td> <td>0</td> </tr> </tbody> </table> <p>C-STN : if $D > 0.1$, unqualified</p>	Dimension	Qualified Quantity	$D \leq 0.1$	Ignore	$0.1 < D \leq 0.15$	2	$0.15 < D \leq 0.20$	1	$D > 0.20$	0	
Dimension	Qualified Quantity										
$D \leq 0.1$	Ignore										
$0.1 < D \leq 0.15$	2										
$0.15 < D \leq 0.20$	1										
$D > 0.20$	0										

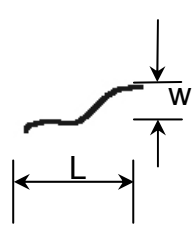
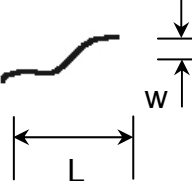
04	LCD black spots, white spots (Line Style)	<p>Unit : mm</p> 		<p>4.1 Small area LCD</p> <table border="1"> <thead> <tr> <th>Length</th> <th>Width</th> <th>Qualified Quantity</th> </tr> </thead> <tbody> <tr> <td>-</td> <td>≤ 0.015</td> <td>Ignore</td> </tr> <tr> <td>≤ 1.0</td> <td rowspan="2">$0.015 < W \leq 0.025$</td> <td>2</td> </tr> <tr> <td>≤ 2.0</td> <td>1</td> </tr> <tr> <td>≤ 1.0</td> <td>$0.025 < W \leq 0.05$</td> <td>1</td> </tr> <tr> <td>-</td> <td>$D > 0.05$</td> <td>According to circle</td> </tr> </tbody> </table>		Length	Width	Qualified Quantity	-	≤ 0.015	Ignore	≤ 1.0	$0.015 < W \leq 0.025$	2	≤ 2.0	1	≤ 1.0	$0.025 < W \leq 0.05$	1	-	$D > 0.05$	According to circle
		Length	Width	Qualified Quantity																		
-	≤ 0.015	Ignore																				
≤ 1.0	$0.015 < W \leq 0.025$	2																				
≤ 2.0		1																				
≤ 1.0	$0.025 < W \leq 0.05$	1																				
-	$D > 0.05$	According to circle																				
<p>4.2 Large area LCD</p>  <table border="1"> <thead> <tr> <th>Length</th> <th>Width</th> <th>Qualified Quantity</th> </tr> </thead> <tbody> <tr> <td>-</td> <td>≤ 0.015</td> <td>Ignore</td> </tr> <tr> <td>≤ 2.0</td> <td rowspan="2">$0.015 < W \leq 0.025$</td> <td>2</td> </tr> <tr> <td>≤ 1.0</td> <td>1</td> </tr> <tr> <td>-</td> <td>$D > 0.05$</td> <td>According to circle</td> </tr> </tbody> </table> <p>CSTN : If $W \geq 0.015$, unqualified Ignore beyond viewing area</p>		Length	Width	Qualified Quantity	-	≤ 0.015	Ignore	≤ 2.0	$0.015 < W \leq 0.025$	2	≤ 1.0	1	-	$D > 0.05$	According to circle							
Length	Width	Qualified Quantity																				
-	≤ 0.015	Ignore																				
≤ 2.0	$0.015 < W \leq 0.025$	2																				
≤ 1.0		1																				
-	$D > 0.05$	According to circle																				
05	LCD Scratch , Threadlike Fiber	<p>Same to NO.3 circle sightline and surface of LCD is vertical (2)Same to NO.3 line style</p>																				
06	POL	<p>It is not admissible that POL is beyond the edge of glass, else, unqualified. It is essential that POL is over the 50 percent of width of frame , else ,unqualified. According to the drawing in case of special definition.</p>																				
07	IC/FPC Bonding	Scratch	Reject																			

		Intensity Of Adhesion	If lower than specification, reject	
		Gold Fold Twist	Reject	
07	IC/FPC Bonding	Silicon	According to outline, no gold outside, seal can not be higher than LCD	
		FPC Gold Sever	Reject	
08	SMT	Lack of Component, Polarity Inverse	If exist, reject	
		Leak Solder, Virtual Solder	If exist, reject	
		Short Circuit In Solder Point	If exist, reject	
		Tin Ball	If exist, reject	
		Tin Acumination	If visual, reject	
		Height Solder Point	If higher 0.5mm than component. reject	
		Height of component	Either side higher 0.5mm than component, reject	

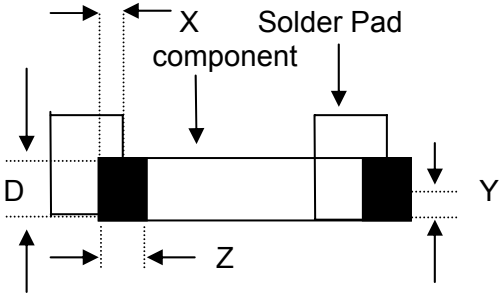
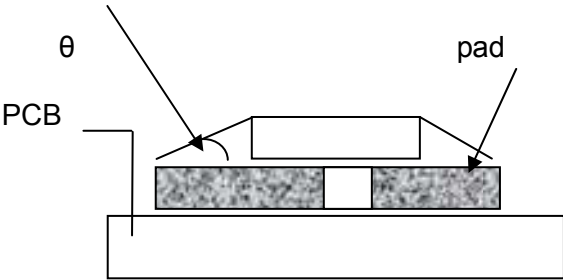
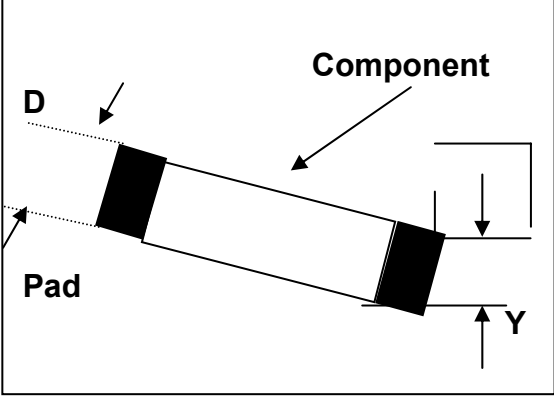
		Component Shift	 <p>$X < 3/4Z$ $y > 1/3D$ reject reject</p>
08	SMT	Few Tin	 <p>If $\theta \leq 20^\circ$ reject</p>
		Component Deflection	 <p>If $Y > 1/3D$ reject</p>
		Component Carcass Sideways	Reject

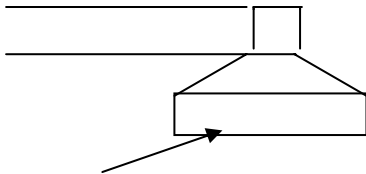
		Component Carcass Sideways	If exist with visual inspection , reject	
		Lot Tin	A: Tin accrete the solder side completely , hollowly ,Ok B: Tin accrete the solder side completely , full circle arc , ok C: Jointing include whole solder side, height of tin>50 percent of height of component, reject	
		Few Tin	A: Tin accrete the solder side completely , hollowly ,Ok B: height of tin > 1/3 of solder side of component , ok C: height of tin ≤ 1/3 of solder side of component, reject	
08	SMT	<p style="text-align: center;">Normal</p>  <p style="text-align: center;">Jointing side</p>		
		Short circuit 、 Open circuit	Forbid	
09	Light	Quality of CSTN Display	1、 Rolling strake with visual inspection, forbid 2、 Differentness of color in viewing area with visual inspection (full white、 red、 green、 blue), forbid 3 、 Display change with visual inspection , forbid	

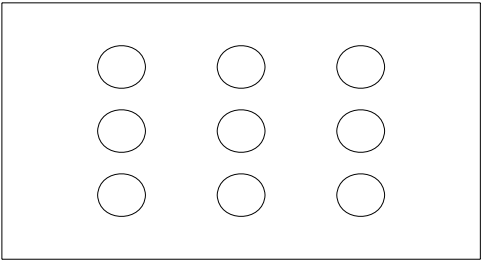
10	Color Of CIE Coordinate		x	y	Drive LCD under normal condition, 25°C $\phi=0$ $\theta=0$ Test white、red、green blue with DMS Record
		white	±0.05	±0.05	
		Red	±0.05	±0.05	
		Green	±0.05	±0.05	
		Blue	±0.05	±0.05	
		According to the specification or sample customer have approved			
11	Brightness	In accord with product specification	Drive condition is according to specification Measure location is in Follow Picture 3、Adjust brightness instrument to zero , burrow against the surface of LCD , press “measure” , record when the display is steady. (YOKOGAWA-3298)		
			 <p style="text-align: center;">Measure location</p>		
12	CR (Max)	According to specification	According to product specification Measure instrument (DMS-501)		
13	Response time	According to specification	According to product specification Measure instrument (DMS-501)		
14	Viewing angle	According to specification	According to product specification Measure instrument (DMS-501)		
15	Vibration、Ring	Compare with the sample customer supply	Compare with the sample customer supply when assemble		
16	Frequency Of FPC Bend	According to the use of product (main FPC of foldaway cell phone ≥ 6 thousand)	Measure instrument Bend angle : 150° Fix FPC in the casement when customer supply		

9 Handling Precautions

9.1 Mounting method

The LCD panel of Daxian LCD module consists of two thin glass plates with polarizers which easily be damaged. And since the module is so constructed as to be fixed by utilizing fitting holes in the printed circuit board.

Extreme care should be needed when handling the LCD modules.

9.2 Caution of LCD handling and cleaning

When cleaning the display surface, Use soft cloth with solvent [recommended below] and wipe lightly

- Isopropyl alcohol
- Ethyl alcohol

Do not wipe the display surface with dry or hard materials that will damage the polarizer surface.

Do not use the following solvent:

- Water
- Aromatics

Do not wipe ITO pad area with the dry or hard materials that will damage the ITO patterns

Do not use the following solvent on the pad or prevent it from being contaminated:

- Soldering flux
- Chlorine (Cl), Sulfur (S)

If goods were sent without being silicic acid coated on the pad, ITO patterns could be damaged due to the corrosion as time goes on.

If ITO corrosion happens by miss-handling or using some materials such as Chlorine (Cl), Sulfur (S) from customer, Responsibility is on customer.

9.3 Caution against static charge

The LCD module uses C-MOS LSI drivers, so we recommend that you:

Connect any unused input terminal to V_{dd} or V_{ss}, do not input any signals before power is turned on, and ground your body, work/assembly areas, assembly equipment to protect against static electricity.

9.4 packing

- Module employs LCD elements and must be treated as such.
- Avoid intense shock and falls from a height.
- To prevent modules from degradation, do not operate or store them exposed direct to sunshine or high temperature/humidity

9.5 Caution for operation

- It is an indispensable condition to drive LCD's within the specified voltage limit since the higher voltage than the limit causes the shorter LCD life.
- An electrochemical reaction due to direct current causes LCD's undesirable deterioration, so that the use of direct current drive should be avoided.
- Response time will be extremely delayed at lower temperature than the operating temperature range and on the other hand at higher temperature LCD's show dark color in them. However those phenomena do not mean malfunction or out of order with LCD's, which will come back in the specified

operation temperature.

- If the display area is pushed hard during operation, some font will be abnormally displayed but it resumes normal condition after turning off once.
- A slight dew depositing on terminals is a cause for electro-chemical reaction resulting in terminal open circuit.

Usage under the maximum operating temperature, 50%Rh or less is required.

9.6 storage

In the case of storing for a long period of time for instance, for years for the purpose or replacement use, the following ways are recommended.

- Storage in a polyethylene bag with the opening sealed so as not to enter fresh air outside in it . And with no desiccant.
- Placing in a dark place where neither exposure to direct sunlight nor light's keeping the storage temperature range.
- Storing with no touch on polarizer surface by the anything else.
[It is recommended to store them as they have been contained in the inner container at the time of delivery from us

9.7 Safety

- It is recommendable to crash damaged or unnecessary LCD's into pieces and wash off liquid crystal by either of solvents such as acetone and ethanol, which should be burned up later.
- When any liquid leaked out of a damaged glass cell comes in contact with your hands, please wash it off well with soap and water

10 Precaution for use

10.1

A limit sample should be provided by the both parties on an occasion when the both parties agreed its necessity. Judgment by a limit sample shall take effect after the limit sample has been established and confirmed by the both parties.

10.2

On the following occasions, the handing of problem should be decided through discussion and agreement between responsible of the both parties.

- When a question is arisen in this specification
- When a new problem is arisen which is not specified in this specifications
- When an inspection specifications change or operating condition change in customer is reported , and some problem is arisen in this specification due to the change.
- When a new problem is arisen at the customer's operating set for sample evaluation in the customer site.

11 Dimensional Outline

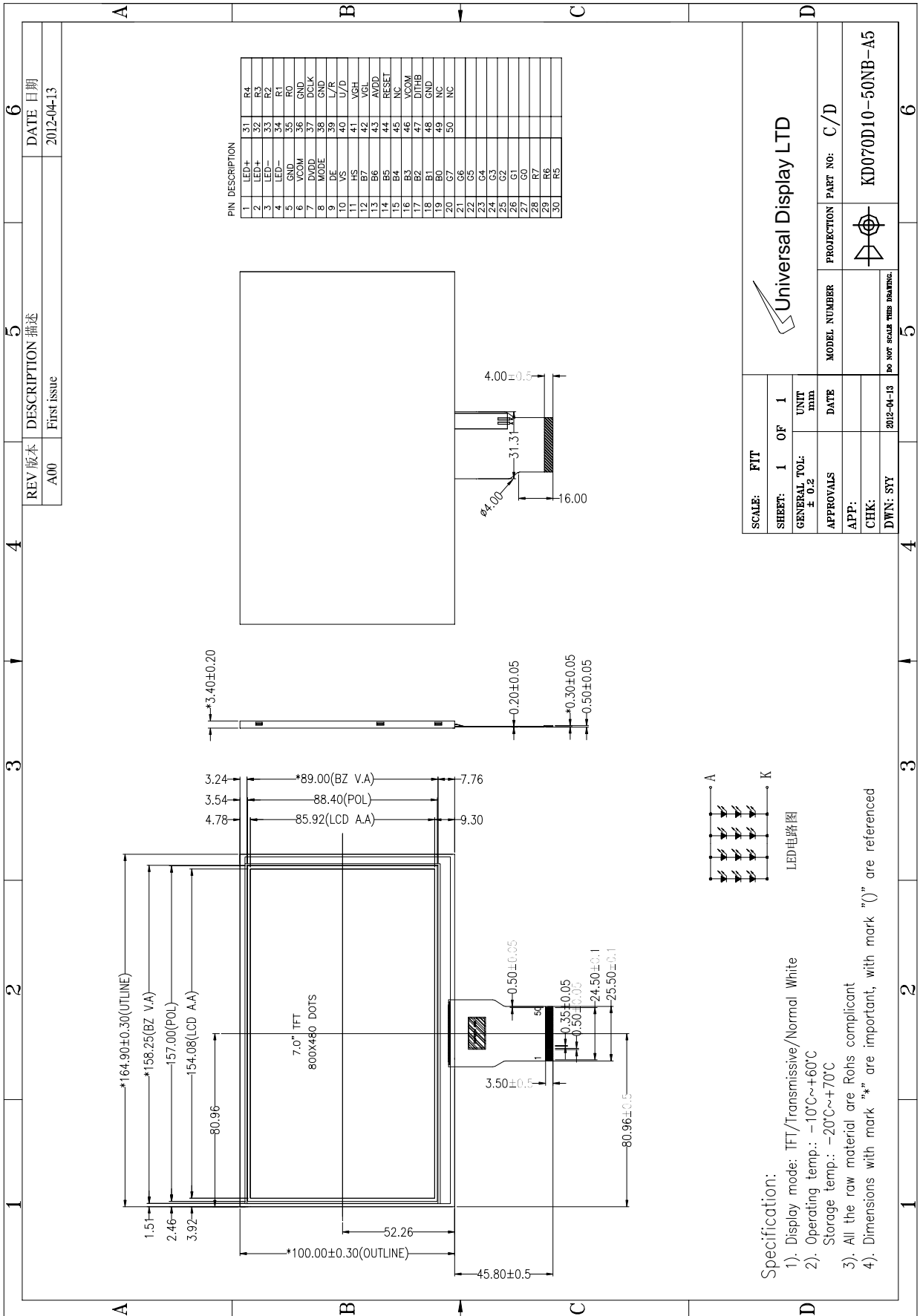

12. Package Drawing

TBD